

2.5.2 The T-matrix approach

The idea consists in assuming a Hamiltonian of the form

$$H(t) = \underbrace{H_S + H_B}_{= H_0} + H_{S-B} e^{\gamma t} \quad (2.100)$$

where $0 < \gamma \ll 1$. Thus the interaction starts adiabatically at $t = -\infty$ and it is turned on completely at $t = 0$. For a large time interval around $t = 0$ the total Hamiltonian contains thus H_S , H_B and H_{S-B} .

Now, let us consider 2 different eigenstates of H_0 , $|i\rangle$ and $|f\rangle$ with associated energies E_i and E_f . Let us further assume that at time t_0 the system and bath combination are in the initial state vector $|i\rangle$.

What is the probability that S+B is in the state vector $|f\rangle$ at time t ?

$$\rho(t_0) = |i\rangle\langle i| \Rightarrow \rho(t) = U(t, t_0) |i\rangle\langle i| U^\dagger(t, t_0) \quad (2.101)$$

Thus, the probability reads

$$P_{fi}(t, t_0) = \text{Tr} \{ |f\rangle\langle f| \rho(t) \} = |\langle f | U(t, t_0) | i \rangle|^2 \quad (2.102)$$

Since $H_0 |i, f\rangle = E_{i, f} |i, f\rangle$ and $U_0(t_2, t_1) = U_0(t_2 - t_1) = \exp\left[-\frac{i}{\hbar} H_0 (t_2 - t_1)\right]$ we can also write (the phases formally disappear!)

$$P_{fi}(t, t_0) = |\langle f | U_S^\dagger(t, 0) U(t, t_0) | i \rangle|^2 = |\langle f | U_I(t, t_0) U_0^\dagger(t_0, 0) | i \rangle|^2 = |\langle f | U_I(t, t_0) | i \rangle|^2$$

where $t = 0$ is conventionally taken as the time at which all representations coincide.

Intermezzo on interaction picture.

Let us consider the time dependent Hamiltonian:

$$H = H_0 + V(t)$$

We can associate to H the time evolution operator $U(t_2, t_1)$ such that

$$U(t_2, t_1) |\psi(t_1)\rangle = |\psi(t_2)\rangle \quad (2.103)$$

Now, let us choose t_0 as the time at which all representations are equal. The evolution in interaction picture is by definition the one that brings $|\psi(t_2)\rangle_I$ into $|\psi(t_2)\rangle_S$. But $|\psi(t_2)\rangle_S = U_0^\dagger(t_2, t_0) |\psi(t_2)\rangle$ and $|\psi(t_2)\rangle_S = U_0^\dagger(t_2, t_0) |\psi(t_2)\rangle$. From (2.73) one obtains

$$U(t_2, t_1) U_0(t_2, t_0) |\psi(t_2)\rangle_S = U_0(t_2, t_0) |\psi(t_2)\rangle_S$$

or

$$\underbrace{U_0^\dagger(t_2, t_0) U(t_2, t_1) U_0(t_2, t_0)}_{U_I(t_2, t_1)} |\psi(t_2)\rangle_S = |\psi(t_2)\rangle_S \quad (2.104)$$

For a closed expression of $U_I(t_2, t_1)$ it is enough to notice that:

$$\frac{\partial}{\partial t_2} U_I(t_2, t_1) = U_0^\dagger(t_2, t_0) V(t_2) U_0(t_2, t_0) U_I(t_2, t_1) \quad \text{and} \quad U_I(t_2, t_2) = 1$$

$$\Rightarrow U_I(t_2, t_1) = T \left\langle \exp \left[\left(-\frac{i}{\hbar} \right) \int_{t_1}^{t_2} dt' U_0^\dagger(t', t_0) V(t') U_0(t', t_0) \right] \right\rangle$$

By integrating now the equation of motion of U_I (Eq. 1.22) we obtain

$$P_{fi}(t, t_0) = \left| \langle f | T_{\leftarrow} \exp \left[\left(-\frac{i}{\hbar} \right) \int_{t_0}^t dt' (H_{S-B} e^{\eta t'}) \right]_I | i \rangle \right|^2 \quad (2.105)$$

Instead of calculating now directly $P_{fi}(t, t_0)$ I concentrate on its
RATE OF CHANGE

$$\Gamma_{fi}(t, t_0) = \frac{d}{dt} P_{fi}(t, t_0) \quad (2.106)$$

The essence of the T-matrix approach to the master equation relies on the evaluation of (2.106) for $t_0 \rightarrow -\infty$ and $\eta \rightarrow 0^+$, in the order.

The statement is that

$$\Gamma_{fi}(t, -\infty) = 2\pi \delta(E_i - E_f) \left| \langle f | T(E_i) | i \rangle \right|^2 \quad (2.107)$$

where

$$T(E_i) = H_{S-B} + H_{S-B} (E_i - H_0 + i0^+)^{-1} T(E_i) \quad (2.107b)$$

is the T-matrix. Let us prove (2.107). First we develop $U_I(t, t_0)$

in series

$$U_I(t, t_0) = T_{\leftarrow} \sum_{n=0}^{\infty} \left(-\frac{i}{\hbar} \right)^n \frac{1}{n!} \prod_{i=1}^n \int_{t_0}^t dt_i (H_{S-B} e^{\eta t_i})_I(t_i)$$

For $n=0$ $\prod_{i=1}^0 = 1$, conventionally. \Rightarrow the rate vanishes because it is time independent.

$$\boxed{n=1} \quad \Gamma_{fi}^{(1)}(t, t_0) = \frac{d}{dt} \left| \langle f | \left(-\frac{i}{\hbar} \right) \int_{t_0}^t dt' (H_{S-B} e^{\eta t'})_I(t') | i \rangle \right|^2 =$$

$$= \left(\frac{d}{dt} F(t) \right) F^*(t) + F(t) \left(\frac{d}{dt} F^*(t) \right) = 2 \operatorname{Re} \left[\left(\frac{d}{dt} F(t) \right) F^*(t) \right]$$

$$= \frac{1}{\hbar^2} 2\text{Re} \left\{ \langle f | e^{iH_0 t/\hbar} H_{S-B} e^{\eta t} e^{-iH_0 t/\hbar} | i \rangle \langle i | \int_{t_0}^t dt' e^{iH_0 t'/\hbar} H_{S-B} e^{\eta t'} e^{-iH_0 t'/\hbar} | f \rangle \right\}$$

$$= \frac{1}{\hbar^2} 2\text{Re} \left\{ \exp \left[\frac{i}{\hbar} (E_f - E_i) t + \eta t \right] \langle f | H_{S-B} | i \rangle \langle i | H_{S-B} | f \rangle \int_{t_0}^t dt' \exp \left[\frac{i}{\hbar} (E_i - E_f) t' + \eta t' \right] \right\}$$

$$= \frac{1}{\hbar^2} |\langle f | H_{S-B} | i \rangle|^2 2\text{Re} \left\{ \exp \left[\frac{i}{\hbar} (E_f - E_i) t + \eta t \right] \cdot \frac{1}{\frac{i}{\hbar} (E_i - E_f) + \eta} \left(\exp \left[\frac{i}{\hbar} (E_i - E_f) t + \eta t \right] - \exp \left[\frac{i}{\hbar} (E_i - E_f) t_0 + \eta t_0 \right] \right) \right\}$$

$t_0 \rightarrow -\infty$

$$= \frac{e^{2\eta t}}{\hbar^2} |\langle f | H_{S-B} | i \rangle|^2 \frac{2\eta}{\left(\frac{E_i - E_f}{\hbar} \right)^2 + \eta^2} \stackrel{\eta \rightarrow 0^+}{=} \frac{2\pi}{\hbar^2} |\langle f | H_{S-B} | i \rangle|^2 \delta \left(\frac{E_i - E_f}{\hbar} \right)$$

$$= \frac{2\pi}{\hbar} |\langle f | H_{S-B} | i \rangle|^2 \delta(E_i - E_f) \quad \checkmark$$

$n=2$

$$\Gamma_{fi}^{(2)}(t, t_0) = \frac{d}{dt} \left| \langle f | \left(-\frac{1}{\hbar^2} \right) \int_{t_0}^t dt_1 \int_{t_0}^{t_1} dt_2 \left(H_{S-B} e^{\eta t_1} \right)_{\mathbb{I}}(t_1) \left(H_{S-B} e^{\eta t_2} \right)_{\mathbb{I}}(t_2) | i \rangle \right|^2$$

$$= \frac{1}{\hbar^4} 2\text{Re} \left\{ \langle f | e^{iH_0 t/\hbar + \eta t} H_{S-B} e^{-iH_0 t/\hbar} \int_{t_0}^t dt_2 e^{iH_0 t_2/\hbar + \eta t_2} H_{S-B} e^{-iH_0 t_2/\hbar} | i \rangle \right.$$

$$\left. \langle i | \int_{t_0}^t dt_1 \int_{t_0}^{t_1} dt_2 e^{iH_0 t_1/\hbar + \eta t_1} H_{S-B} e^{-iH_0 t_1/\hbar} e^{iH_0 t_2/\hbar + \eta t_2} H_{S-B} e^{-iH_0 t_2/\hbar} | f \rangle \right\}$$

$$= \frac{1}{\hbar^4} 2\text{Re} \left\{ \exp \left[\frac{i}{\hbar} E_f t + \eta t \right] \langle f | H_{S-B} e^{-iH_0 t/\hbar} \left(\frac{iH_0}{\hbar} + \eta - \frac{iE_i}{\hbar} \right)^{-1} \left(\exp \left[\frac{i}{\hbar} H_0 t + \eta t - \frac{i}{\hbar} E_i t \right] \right) H_{S-B} | i \rangle \right.$$

$$\left. \int_{t_0}^t dt_1 \int_{t_0}^{t_1} dt_2 \exp \left[\frac{i}{\hbar} E_i t_1 + \eta t_1 \right] \langle i | H_{S-B} \exp \left[-\frac{i}{\hbar} H_0 (t_1 - t_2) \right] H_{S-B} | f \rangle e^{\eta t_2 - \frac{i}{\hbar} E_f t_2} \right\}$$

$$= \frac{1}{\hbar^4} 2\text{Re} \left\{ \exp \left[\frac{i}{\hbar} (E_f - E_i) t + 2\eta t \right] \langle f | H_{S-B} \left(\frac{i}{\hbar} H_0 + \eta - \frac{i}{\hbar} E_i \right)^{-1} H_{S-B} | i \rangle \right.$$

$$\left. \int_{t_0}^t dt_1 \exp \left[\frac{i}{\hbar} E_i t_1 + \eta t_1 \right] \langle i | H_{S-B} \left(\frac{i}{\hbar} H_0 - \frac{i}{\hbar} E_f + \eta \right)^{-1} e^{-\frac{i}{\hbar} H_0 t_1} \right.$$

$$\left. \cdot \exp \left[\left(\frac{i}{\hbar} H_0 - \frac{i}{\hbar} E_f + \eta \right) t_1 \right] H_{S-B} | f \rangle \right\} =$$

$$= \frac{1}{\hbar^4} 2\text{Re} \left\{ \exp \left[\frac{i}{\hbar} (E_f - E_i) t + 2\eta t \right] \langle f | H_{S-B} \left(\frac{i}{\hbar} H_0 + \eta - \frac{i}{\hbar} E_i \right)^{-1} H_{S-B} | i \rangle \right.$$

$$\left. \langle i | H_{S-B} \left(\frac{i}{\hbar} H_0 + \eta - \frac{i}{\hbar} E_f \right)^{-1} H_{S-B} | f \rangle \frac{1}{\frac{i}{\hbar} (E_i - E_f) + 2\eta} \exp \left[\frac{i}{\hbar} (E_i - E_f) t + 2\eta t \right] \right\}$$

$$= \frac{1}{\hbar^4} \left| \langle f | H_{S-B} \left(\frac{i}{\hbar} (H_0 - E_i) + 0^+ \right)^{-1} H_{S-B} | i \rangle \right|^2 2\pi \hbar \delta(E_i - E_f)$$

$$= \frac{2\pi}{\hbar} \left| \langle f | H_{S-B} (E_i - H_0 + i0^+)^{-1} H_{S-B} | i \rangle \right|^2 \delta(E_i - E_f) \quad \checkmark$$

In order to extract the matrix elements from the Re function we have used the relation

$$\langle f | H_{S-B} \left(\frac{i}{\hbar} (H_0 - E_i) + \eta \right)^{-1} H_{S-B} | i \rangle = \langle i | H_{S-B} \left(\frac{i}{\hbar} (H_0 - E_f) + \eta \right)^{-1} H_{S-B} | f \rangle^*$$

which can be proven as follows:

$$\langle f | H_{S-B} \left(\frac{i}{\hbar} (H_0 - E_i) + \eta \right)^{-1} H_{S-B} | i \rangle^* = \sum_m \left(\langle f | H_{S-B} | m \rangle \frac{1}{\frac{i}{\hbar} (E_m - E_i) + \eta} \langle m | H_{S-B} | i \rangle \right)^*$$

$$= \sum_m \langle i | H_{S-B} | m \rangle \frac{1}{\frac{i}{\hbar} (E_i - E_m) + \eta} \langle m | H_{S-B} | f \rangle = \sum_{m'} \langle i | H_{S-B} | m' \rangle \frac{1}{\frac{i}{\hbar} (E_{m'} - E_f) + \eta} \langle m' | H_{S-B} | f \rangle$$

$$E_{m'} = E_i + E_f - E_m$$

The connection to the master equation is obtained by choosing both $|i\rangle$ and $|f\rangle$ as product states of $|n\rangle_S \otimes |i\rangle_B$ and $|m\rangle_S \otimes |f\rangle_B$. The rate from $n \rightarrow m$ is then constructed as

$$\tilde{\Gamma}_{n \rightarrow m} = 2\pi \sum_{i,f} W_i |\langle f|_B \otimes \langle m|_S \langle T | n\rangle_S \otimes |i\rangle_B|^2 \delta(E_n + \epsilon_i - E_m - \epsilon_f)$$

where $E_m(\epsilon_i)$ are eigenenergies of system (bath) states and W_i is the probability to find the bath in the initial state $|i\rangle_B$.

The factorization assumption is about the $S+B$ at time $t_0 \rightarrow -\infty$ and is analogous to the $\rho = \rho_S \otimes \rho_B$ of the density operator approach.

The next step is the identification of $\tilde{\Gamma}_{n \rightarrow m}$ with the rates W_{mn} of (2.47). More specifically $\tilde{\Gamma}_{n \rightarrow m} = W_{mn}$ when evaluated to lowest order in H_{S-B} . Otherwise it should be considered as a generalization.

Notice that the rate $\tilde{\Gamma}_{n \rightarrow m}$ represents the variation of the population per unit time of the state $|m\rangle$ at time t under the assumption that the system was in $|n\rangle$ at time $t_0 \rightarrow -\infty$. The rate Γ_{mn} in the BRE represents the rate of transition at EQUAL time. \Rightarrow , in principle a different concept. To lowest order in H_I , though, they coincide since multiple interaction events interspersed by free system evolution are neglected.

PART II

QUANTUM TRANSPORT

(in interacting nanostructures)

Chapter 3 Basic concepts of quantum transport

3.1 Mesoscopic conductor

Electronic transport in mesoscopic systems is a field of condensed matter physics emerged in the late 1970s. It deals with systems containing several thousand of atoms, and thus bridging between the macroscopic classical world and the microscopic quantum realm. This is encoded in the word itself mesoscopic (van Kampen, 1976)

μέσος : in the middle
σκοπέω : to look at, to observe
(φύσις : nature)

If L is the system size, it holds:

$$1 \text{ nm} \gg L \gg a_0 \quad (3.1)$$

where $a_0 \sim 0.5 \text{ \AA}$ is the Bohr radius. This is a vast field. We shall focus in the following on coherent nanostructures, which have become object of intense investigation from the middle 1990s. They include semiconducting heterostructures, molecular junctions or carbon-based nanostructures. In order to fix better the ideas let me introduce 3 characteristic length scales:

- 1- de Broglie wavelength λ
- 2- mean free path L_m
- 3- phase-relaxation length L_φ

1 - de Broglie wavelength λ :

$$\lambda = \frac{h_0}{m v} \quad (3.2)$$

This length is a measure of the wave particle duality. On length scales much larger than λ a system behaves classically. For a 2DEG the typical λ taken for electrons at $v = v_F$ is $\lambda_F \approx 35 \text{ nm}$.

2 - mean free path L_m .

An electron in a perfect crystal moves as in vacuum but with an effective mass. Nevertheless there are impurities, phonons, other electrons which disturb this simple picture. L_m is usually defined as $L_m = v_F \tau_m$ where τ_m is the average time an electron takes to change its momentum. In other words, given an initial distribution peaked at \vec{k} , the time it takes to equilibrate. (Notice that e-e does not contribute to the τ_m since it conserves - probably - the electronic momentum).

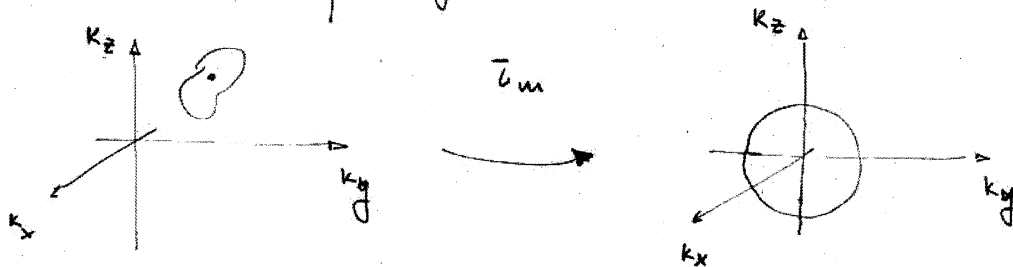

Again in a 2DEG typically $L_m = 30 \mu\text{m}$ and $\tau_m \approx 100 \text{ ps}$

3 - phase-relaxation length L_ϕ . Electrons (and all quantum system in general) acquire a phase in time associated to their energy. This is also what ensures the (phase coherent) space propagation of a wave packet:

$$\psi(x, t_0) = \int dk e^{-\alpha^2(k-k_0)^2} e^{i k x} e^{-i \omega_k t_0} \quad (3.3)$$

assuming for example a linear dispersion relation $\omega = ck$

$$\psi(x, t_0) = \int_{-\infty}^{+\infty} dk e^{-\alpha^2(k-k_0)^2} e^{ik(x-ct)} = e^{-\frac{(x-ct)^2}{4\alpha^2}} \underbrace{e^{ik_0(x-ct)}}_{e^{i\phi(t)}}$$

In case of dephasing processes, inelastic processes change the energy of the propagating particle \Rightarrow its phase. A typical experiment to measure dephasing length is an Aharonov-Bohm ring.

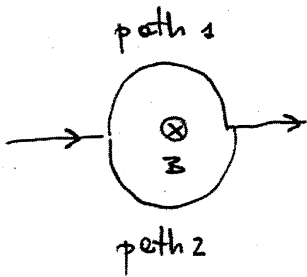

The conductance through the system show oscillations as a function of the magnetic field. The amplitude of the oscillations is reduced by dephasing processes.

Using the characteristic lengths we can classify:

$L \gg L_m$	diffusive	} conventional transport
$L \gg L_\varphi$	incoherent	
$L \gg \lambda$	(semiclassical)	

$L \ll L_m$	ballistic	} \rightarrow Mesoscopic transport
$L \ll L_\varphi$	coherent	
$L \ll \lambda$	quantum mechanical	

What we have in mind is an electrical circuit of which the nanostructure is part. The nanostructure is connected to "electron reservoirs" or "contacts" kept at different electrochemical potentials which allow transfer of charge or other degrees of freedom e.g. spin, energy associated to the carrier. We deal with open quantum systems, where the contacts are seen as thermalized subsystems.

A generic nanostructure is considered typically in two different ways, depending on "how good" the coupling to the reservoir is:

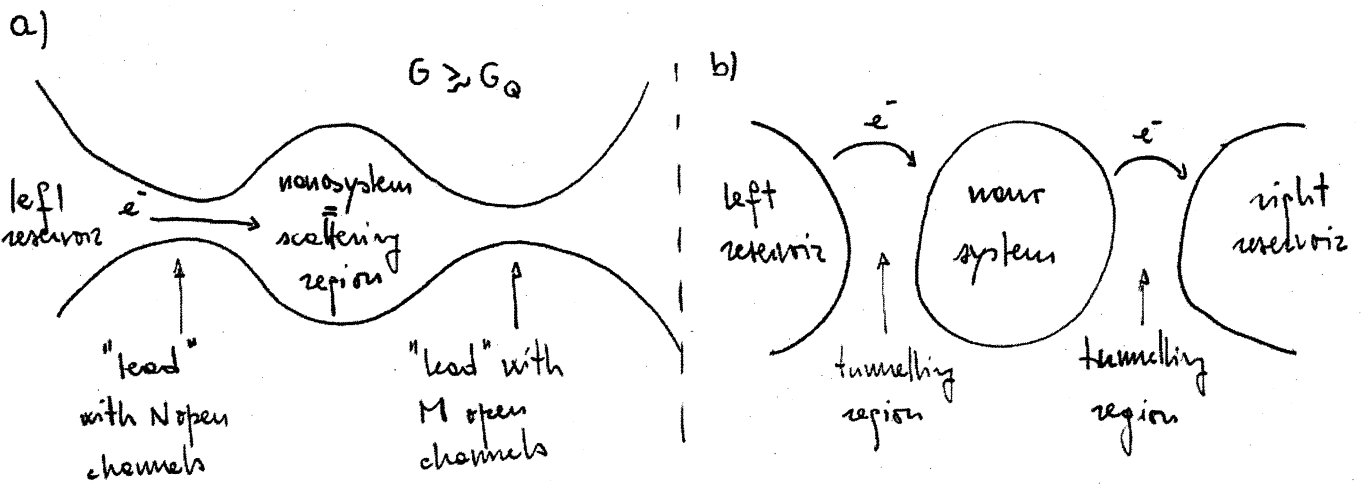

A measure of how strong the contacts are, is provided by the ratio G/G_0 between the conductance G of the nanostructure:

$$G = \lim_{V \rightarrow 0} \frac{dI}{dV}$$

and the conductance quantum $G_0 = \frac{2e^2}{h}$. If $G \gg G_0$ many electrons traverse a nanostructure simultaneously. This occurs via several transport channels represented by the ideal leads. Often a description of the central region as "scattering region" is performed. The scattering formalism of Landauer and Buttiker is then a powerful tool to describe these systems in particular in absence of e-e interaction.

3.2 A QUANTUM POINT CONTACT

Nanostructures can be designed and manufactured with several methods. One possibility is to pattern them on the top of a GaAs/AlGaAs based heterostructure or of other sources of 2DEGs. (e.g. a graphene layer) by standard lithographic techniques. To this extent one exploits the fact that a 2DEG forms at the interface between

GeAs and AlGeAs. To laterally confine the electrons one defines a metallic pattern on top of the heterostructure. Applying a negative gate voltage depletes the electrons under the pattern, thereby confining the electrons to the ungated region.

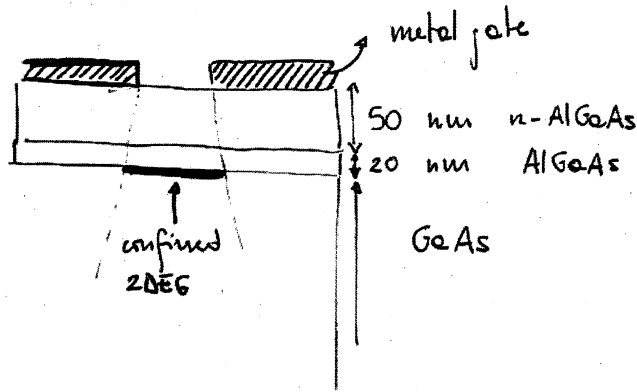

a) Cross section of a laterally confined 2DEG

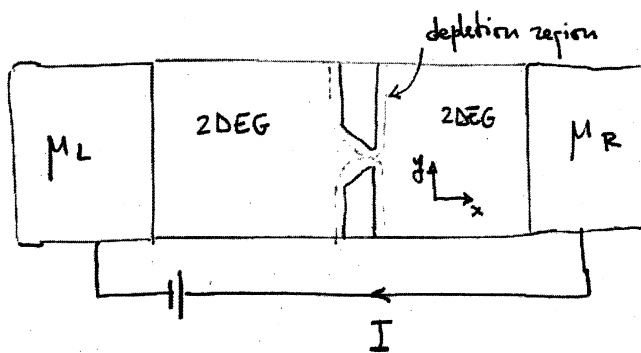

b) Top view of a quantum point contact. (QPC)

Alternatively one starts from "natural" nanostructures as eg. molecules, self assembled QDs, self assembled nanowires, carbon nanotubes and integrates them in electrical circuits via different techniques.

From a theoretical point of view a QPC is described by electrons in a 2 dimensional confinement with an additional x dependent confinement in the y direction. Because the confinement is largest at the bottle neck, this induces an effective barrier for the electrons to travel along the longitudinal direction. (x)

In general one can look at the QPC as an electron wave guide of variable cross section. We assume an adiabatic wave guide i.e. with dimensions varying so smoothly that a factorizing Ansatz still holds.

i) Confinement constant in x

$$\Psi_n(x, y) = \Phi_n(y) e^{ikx}$$

$$E = E_n + \frac{\hbar^2 k_x^2}{2m^*}$$

$$E_n = \frac{\pi^2 \hbar^2}{8m^*} \frac{n^2}{a^2}$$

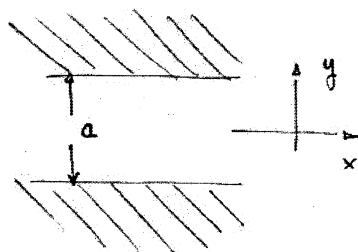

ii) Adiabatic confinement

$$\Psi_n(x, y) = \varphi_n(x) \Phi_n(y; x)$$

$$E_n = E_n(x) = \frac{\pi^2 \hbar^2}{8m^*} \frac{n^2}{a(x)^2}$$

$\varphi(x)$ satisfies the equation $\left(-\frac{\hbar^2}{2m^*} \frac{\partial^2}{\partial x^2} + E_n(x) \right) \varphi_n(x) = E \varphi_n(x)$

We have discrete energy levels ("subbands" or "modes") due to the confinement. The term $E_n(x)$ plays the role of a potential barrier for the longitudinal motion. Moreover the barrier becomes larger upon increasing n . If we assume as first approximation an impenetrable barrier \Rightarrow we can count the number of open channels: $E_n(x) < E_F \quad \forall x$.

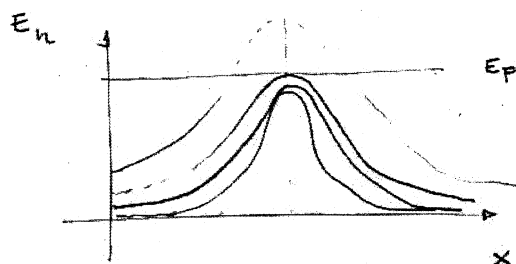

3 channels open.

In general, though, the barrier is not impenetrable and one

obtains an energy dependent transmission coefficient $T_n(E)$.
 $T_n(E)$ is obtained by solving the scattering problem.

Eg. The transmission through a rectangular barrier results:

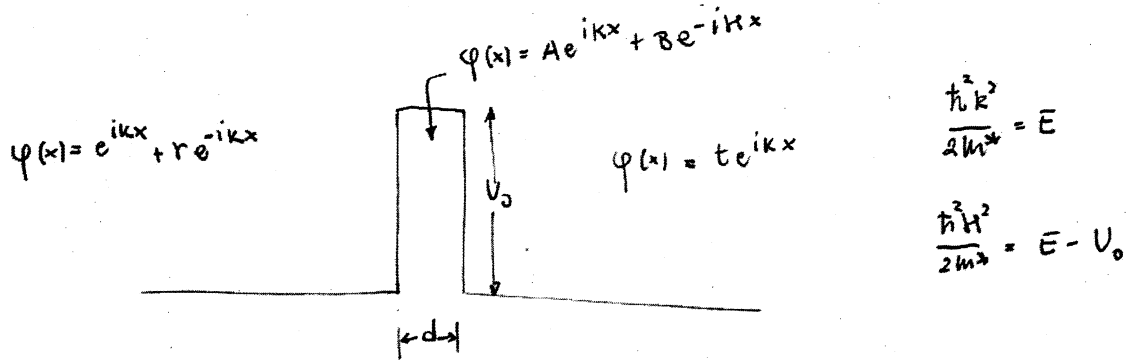

by imposing $\varphi(x)$ to be C^1 on \mathbb{R}

$$T(E) \equiv t^2 = \frac{1}{1 + \left(\frac{\sin kd (k^2 - k^2)}{2kK} \right)^2}$$

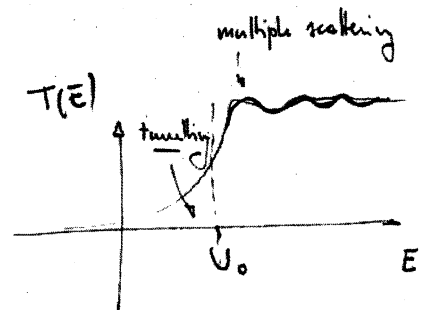

One striking result first observed when measuring the conductance $G = \lim_{V \rightarrow 0} \frac{dI}{dV}$ of a QPC vs. gate voltage V_g (B.J. van Wees et al. PRB 43 12431 (1991)) is that at low temperatures it changes in steps of $\frac{2e^2}{h} = G_0$, i.e. it is QUANTIZED. Each step reflects a new transverse subband entering the transport window $\mu_L - \mu_R$. In order to evaluate the current we first observe that since there are no sinks or sources I is equal in every cross section. We take conveniently one far from the bottle neck. As a second assumption we take the impenetrable barrier potential $\Rightarrow T_n = 0, 1$ for closed, open channels respectively. It follows for the current

$$I = 2e \sum_n \frac{1}{L} \sum_{k_x} \left[\frac{1}{\hbar} \frac{\partial \epsilon_n}{\partial k_x} f_L(\epsilon_n) T_n(\epsilon_n) + \frac{1}{\hbar} \frac{\partial \epsilon_n}{\partial (-k_x)} f_R(\epsilon_n) T(\epsilon_n) \right] \quad (3.4)$$

where $f_{L,R}(\epsilon) = \frac{1}{1 + e^{\beta(\epsilon - \mu_{L,R})}}$ (3.5)

Thus, with $\frac{1}{L} \sum_{\mathbf{k}_x} \rightarrow \frac{1}{2\pi} \int d\mathbf{k}_x = \frac{1}{2\pi} \int d\epsilon \frac{\partial \mathbf{k}_x}{\partial \epsilon}$ and impenetrable barrier

$$I = \frac{2e}{h} N_{\text{open}} \int d\epsilon (f_L(\epsilon) - f_R(\epsilon)) = \frac{2e}{h} N_{\text{open}} (\mu_L - \mu_R)$$

$$\Rightarrow G = \left. \frac{dI}{dV} \right|_{V=0} = \frac{2e^2}{h} N_{\text{open}}$$

3.3 Tunneling structures

In the following we shall discuss quantum transport for systems in the low conductance regime $G \ll G_0$ which can be conveniently described by a Hamiltonian of the form (cf. 2.7)

$$\hat{H} = \hat{H}_{\text{res}} + \hat{H}_S + \hat{H}_T \quad (3.6)$$

where the tunnelling Hamiltonian \hat{H}_T provides the coupling of the system to the contacts and is considered as a perturbation. One can think to various realizations of the Hamiltonian (3.6), e.g. in STM set-ups where the system of interest is e.g. an atom or a molecule on a thin insulating substrate.

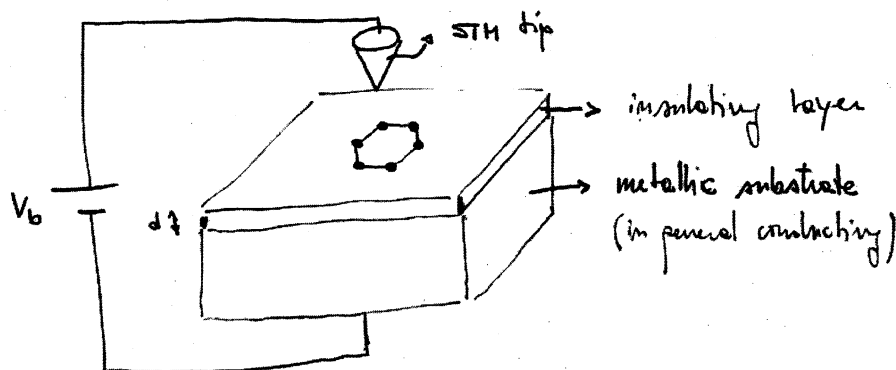

The entire structure is immersed in ultra high vacuum. The vacuum region between the tip and the molecule and the insulating region (of thickness d) between the molecule and the conducting substrate provides tunneling barriers. In the example sketched, we consider a planar molecule (benzene), whose molecular orbitals decay exponentially along the z direction on a length scale a_z . We can think the electrons in a potential (scalar field) $V(\vec{r})$. If we restrict to the "relevant" combination in which the tip is standing above the molecule and we plot $V(x_{tip}, y_{tip}, z)$, we can visualize the relevant parameters for the device

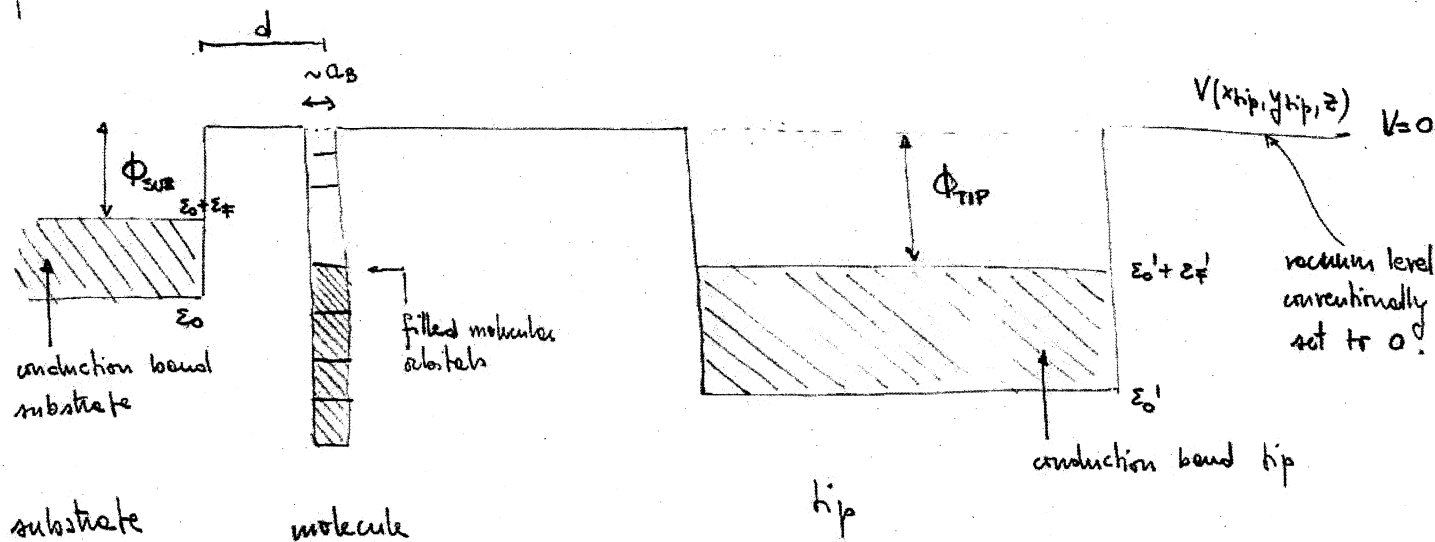

One other possibility is provided by a quantum dot electrostatically defined in a 2DEG or obtained by contacting a carbon nanotube or a molecule to metal with large contact resistance. (e.g. gold)

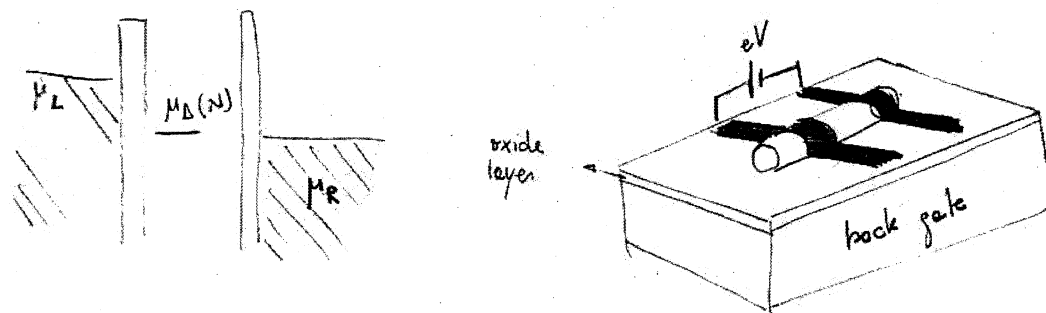

The Hamiltonian (3.6) has the same form of (2.7) where the correspondence between the open system and the tunneling structure is given by

$$\begin{aligned} H_B &\rightarrow H_{res} \\ H_{SB} = V &\rightarrow H_T \end{aligned} \quad (3.7)$$

In the following we shall evaluate the current-voltage characteristics of such nanostructures based on the density-matrix formalism, using the expression:

$$I_L = \text{Tr} \{ \hat{\rho}_{tt} \hat{I}_L \} = \text{Tr}_{\text{sys}} \{ \text{Tr}_{\text{res}} \{ \hat{\rho}_{tt} \hat{I}_L \} \} \quad (3.8)$$

where \hat{I}_L is the current operator through the left reservoir (playing the role of "source" if the applied bias $V > 0$). An expression for the current operator can be readily obtained from:

$$\begin{aligned} I_L &= -\frac{d}{dt} \langle e\hat{N}_L \rangle = -\frac{d}{dt} \text{Tr} \{ e\hat{N}_L \hat{\rho}_{tt}(t) \} = -\text{Tr} \{ e\hat{N}_L \left(\frac{i}{\hbar} [\hat{H}, \hat{\rho}(t)] \right) \} = \\ &= +\frac{i}{\hbar} \text{Tr} \{ e\hat{N}_L \hat{H} \hat{\rho}(t) \} - \frac{i}{\hbar} \text{Tr} \{ e\hat{N}_L \hat{\rho}(t) \hat{H} \} = \text{cyclic property of the trace} \\ &= \text{Tr} \left\{ \frac{i}{\hbar} e [\hat{N}_L, \hat{H}] \hat{\rho}(t) \right\} \quad \rightarrow \end{aligned}$$

$$\boxed{\hat{I}_L = e \frac{i}{\hbar} [\hat{N}_L, \hat{H}]} \quad (3.9) \quad \Rightarrow \quad \boxed{\hat{I}_L = e \frac{i}{\hbar} [\hat{N}_L, \hat{H}_T]} \quad (3.9b)$$

where \hat{N}_L is the number operator of the left contact. Thus, in this approach, the quantity to be determined is the total density operator $\hat{\rho}_{tt}$ and, in turn, the reduced density matrix $\hat{\rho}_{red} = \text{Tr}_{\text{res}} \{ \hat{\rho}_{tt} \}$ (3.10)

For example, let us consider as an example the Anderson impurity model

$$\hat{H} = \overbrace{\sum_{k\sigma\alpha} \epsilon_k c_{k\sigma\alpha}^\dagger c_{k\sigma\alpha}}^{\hat{H}_{res}} + \overbrace{\sum_{\sigma} \epsilon_D d_{\sigma}^\dagger d_{\sigma}}^{\hat{H}_S} + \overbrace{t_{\alpha} \sum_{k\sigma} (c_{k\sigma}^\dagger d_{\sigma} + d_{\sigma}^\dagger c_{k\sigma})}^{\hat{H}_T} \quad (3.11)$$

where $\alpha = L, R$, $\sigma = \uparrow, \downarrow$ and k is the momentum of the electron in the lead. It follows that

$$\begin{aligned} \hat{I}_L &= e \frac{i}{\hbar} \left[\sum_{k\sigma} c_{k\sigma}^\dagger c_{Lk\sigma}, \hat{H} \right] = \hat{N}_L \text{ commutes with } H_S \text{ and } H_{res} \\ &= e \frac{i}{\hbar} \sum_{k\sigma} \left[c_{k\sigma}^\dagger c_{Lk\sigma}, \hat{H}_T \right] = e \frac{i}{\hbar} \sum_{k\sigma} \sum_{\alpha q\tau} \left[c_{k\sigma}^\dagger c_{Lk\sigma}, t_{\alpha} (c_{\alpha q\tau}^\dagger d_{\tau} + d_{\tau}^\dagger c_{\alpha q\tau}) \right] \\ &= e \frac{i}{\hbar} \sum_{k\sigma} \sum_{\alpha q\tau} t_{\alpha} \left([c_{k\sigma}^\dagger c_{Lk\sigma}, c_{\alpha q\tau}^\dagger] d_{\tau} + d_{\tau}^\dagger [c_{k\sigma}^\dagger c_{Lk\sigma}, c_{\alpha q\tau}] \right) \\ &= e \frac{i}{\hbar} \sum_{k\sigma} \sum_{\alpha q\tau} t_{\alpha} (c_{Lk\sigma}^\dagger \delta_{\tau} - d_{\tau}^\dagger c_{Lk\sigma}) \delta_{\alpha L} \delta_{qk} \delta_{\sigma\tau} = \\ &= e \frac{i}{\hbar} \sum_{k\sigma} t_L (c_{Lk\sigma}^\dagger d_{\sigma} - d_{\sigma}^\dagger c_{Lk\sigma}) \quad (3.12) \end{aligned}$$

The current operator is a mixed system and reservoir operator. This is a common feature in this approach. Since then the expectation values of operators is independent of the representation one can write:

$$I_L(t) = \text{Tr} \left\{ \hat{I}_{L,I}(t) \tilde{\rho}_I(t) \right\} \quad (3.13)$$

Notice that, in principle, the time evolution of the entire density operator $\hat{\rho}_I(t)$ is needed to evaluate (3.13).

An alternative way of calculating the current through the system is to relate it to the variation of charge ON THE SYSTEM. In this approach, though we have access at first order only to the sum of the current to the different leads:

$$\begin{aligned} I_L + I_R &= \frac{d}{dt} \text{Tr} \{ \hat{N}_S \rho(t) \} = \frac{d}{dt} \text{Tr}_{\text{sys}} \{ \hat{N}_S \text{Tr}_{\text{res}} \{ \hat{\rho}(t) \} \} = \\ &= \text{Tr}_{\text{sys}} \{ \hat{N}_S \dot{\rho}_{\text{red}}(t) \} \end{aligned} \quad (3.14)$$

This expression of the current depends now on the equation of motion for the reduced density matrix. If we analyze the simple case in which $\dot{\rho}_{\text{red}}(t) = \mathcal{L} \rho_{\text{red}}(t)$. (e.g. second order Markov approximation) it is easy to separate \mathcal{L} into a right and a left contribution $\mathcal{L} = \mathcal{L}_L + \mathcal{L}_R$ and thus obtain:

$$I_\alpha = \text{Tr}_{\text{sys}} \{ \hat{N}_S \mathcal{L}_\alpha \rho_{\text{red}}(t) \}. \quad (3.15)$$

In practice 3.15 can always be transformed into $\text{Tr}_{\text{res}} \{ I_\alpha \rho_{\text{red}}(t) \}$

Notice that, if we calculate the current using $\frac{d}{dt} \langle N_\alpha \rangle$ or $\frac{d}{dt} \langle N_S \rangle$ we need, at first sight, different informations about the evolution of the density operator. Let us return to this purpose to the Nakajima-Zwanzig approach. This time we will keep the interaction picture.

$$\rho_I(t) = \rho_I(t) + Q \rho_I(t) \quad \text{where} \quad \rho_I = \text{Tr}_{\text{res}} \{ \rho \} \otimes \rho_{\text{res}}$$

If now we write $H_I = \sum_i Q_i F_i$ and F_i does not conserve the particle number on the lead $\Rightarrow \text{Tr}_{\text{res}} \{ F_i \rho_{\text{res}} \} = 0$ the same for $\text{Tr}_{\text{res}} \{ N_\alpha F_i \rho_{\text{res}} \}$

It follows that:

$$\begin{aligned}
 I_\alpha &= \text{Tr} \left\{ \hat{I}_{\alpha I} \hat{\rho}_I \right\} = \text{Tr} \left\{ \hat{I}_{\alpha I} (\hat{\rho} \hat{\rho}_I + Q \hat{\rho}_I) \right\} = \\
 &= \text{Tr} \left\{ e^{\frac{i}{\hbar} [\hat{N}_\alpha, \hat{H}_{T,I}]} \hat{\rho} \hat{\rho}_I + e^{\frac{i}{\hbar} [\hat{N}_\alpha, \hat{H}_{T,I}]} Q \hat{\rho}_I \right\} \quad (3.16)
 \end{aligned}$$

But $\hat{\rho} \hat{\rho}_I = \text{Tr}_B \{ \rho_I \} \otimes \rho_B$ conserves the reservoir particle number while $\hat{H}_{T,I}$ doesn't $\Rightarrow \text{Tr}_{\text{res}} \{ e^{\frac{i}{\hbar} [\hat{N}_\alpha, \hat{H}_{T,I}]} \hat{\rho} \hat{\rho}_I \} = 0$ and the first term in (3.16) vanishes. We are left with

$$I_\alpha = \text{Tr} \left\{ \hat{I}_{\alpha I} Q \hat{\rho}_I \right\} \quad (3.17)$$

In summary, if the current is calculated as $-\frac{d}{dt} \langle N_L \rangle$ we obtain that only the non-factorized component of the density operator contributes to the calculation of the average. In the other case

$$\begin{aligned}
 I_L + I_R &= e \frac{d}{dt} \text{Tr} \left\{ \hat{N}_s \rho_I(t) \right\} = e \frac{d}{dt} \text{Tr}_{\text{sys}} \left\{ \hat{N}_s \text{Tr}_{\text{res}} \left\{ \rho_I(t) \right\} \right\} = \\
 &= e \frac{d}{dt} \text{Tr} \left\{ \hat{N}_s \hat{\rho} \hat{\rho}_I \right\} = \boxed{e \text{Tr} \left\{ \hat{N}_s \hat{\rho} \dot{\rho}_I \right\}} \quad (3.18)
 \end{aligned}$$

and only the time evolution of the factorized component of ρ_I is apparently needed. The connection between the two approaches is obtained by remembering that (for factorized initial conditions)

$$\begin{aligned}
 Q \rho_I(t) &= \int_0^t ds G_{QI}(t,s) Q \rho_I(s) \\
 \dot{\rho}_I &= \hat{\rho} \mathcal{L}_{II}^{(H)} \int_0^t ds G_{QI}(t,s) Q \rho_I(s) = \hat{\rho} \mathcal{L}_{II}^{(H)} Q \rho_I(t) \quad (3.18b)
 \end{aligned}$$

where $G_{QI}(t,s) = T_\leftarrow \exp \left(\int_s^t dt' Q_{II}(t') \right)$

Let's consider the Liouville equation in interaction picture

$$\dot{\rho}_I = L_{T,I}(t) \rho_I(t),$$

and project it using the projection operator P and Q

$$P \dot{\rho}_I = P L_{T,I}(t) P \rho_I(t) + P L_{T,I}(t) Q \rho_I(t)$$

$$Q \dot{\rho}_I = Q L_{T,I}(t) P \rho_I(t) + Q L_{T,I}(t) Q \rho_I(t)$$

By introducing the propagator $G_{Q,I}(t,s)$ we can solve the second equation formally.

$$\frac{d}{dt} [G_{Q,I}(0,t) Q \rho_I] = G_{Q,I}(0,t) Q L_{T,I}(t) Q \rho_I(t) = G_{Q,I}(0,t) Q L_{T,I}(t) P \rho_I(t)$$

$$\Rightarrow G_{Q,I}(0,t) Q \rho_I(t) - Q \rho_I(0) = \int_0^t ds G_{Q,I}(0,s) Q L_{T,I}(s) P \rho_I(s)$$

Multiplication by $G_{Q,I}(t,0)$ from the left gives

$$Q \rho_I(t) = \underbrace{G_{Q,I}(t,0) Q \rho_I(0)}_{=0 \text{ since } \rho_I(0) = \rho_{\text{eq}}(0) \otimes \rho_{\text{B}}} + \int_0^t ds G_{Q,I}(t,s) Q L_{T,I}(s) P \rho_I(s)$$

Notice that the Q projector appearing before $L_{T,I}$ in the previous equation can be eliminated since $P L_{T,I}(s) P = 0$

The equations (3.17) and (3.18) represent two alternative expressions for the current. We want now prove their equivalence. More precisely the statement is:

$$\sum_{\alpha} \text{Tr} \{ \hat{I}_{\alpha, I} Q \hat{\rho}_I \} = e \text{Tr} \{ \hat{N}_S Q \hat{\rho}_I \} \quad (3.19)$$

proof

$$\begin{aligned} \sum_{\alpha} \text{Tr} \{ \hat{I}_{\alpha, I} Q \hat{\rho}_I \} &= \sum_{\alpha} \text{Tr} \{ e^{\frac{i}{\hbar}} [\hat{N}_{\alpha}, \hat{H}_{T, I}] Q \hat{\rho}_I \} = \\ &\stackrel{(1)}{=} \sum_{\alpha} \text{Tr} \{ e^{\frac{i}{\hbar}} [\hat{N}_{\alpha}, \hat{H}_I] Q \hat{\rho}_I \} \stackrel{(2)}{=} \text{Tr} \{ e^{\frac{i}{\hbar}} [\sum_{\alpha} \hat{N}_{\alpha}, \hat{H}_I] Q \hat{\rho}_I \} = \\ &\stackrel{(3)}{=} \text{Tr} \{ e^{\frac{i}{\hbar}} [\hat{N} - \hat{N}_S, \hat{H}_I] Q \hat{\rho}_I \} \stackrel{(4)}{=} \text{Tr} \{ -e^{\frac{i}{\hbar}} [\hat{N}_S, \hat{H}_I] Q \hat{\rho}_I \} = \\ &\stackrel{(5)}{=} \text{Tr} \{ -e^{\frac{i}{\hbar}} [\hat{N}_S, \hat{H}_{T, I}] Q \hat{\rho}_I \} \stackrel{(6)}{=} \text{Tr} \{ e^{\frac{i}{\hbar}} [\hat{H}_{T, I}, \hat{N}_S] Q \hat{\rho}_I \} - \text{Tr} \{ e^{\frac{i}{\hbar}} [\hat{H}_{T, I}, Q \hat{\rho}_I] \} \\ &\stackrel{(7)}{=} \text{Tr} \{ e^{\frac{i}{\hbar}} \hat{N}_S (-\frac{i}{\hbar}) [\hat{H}_{T, I}, Q \hat{\rho}_I] \} \stackrel{(8)}{=} e \text{Tr} \{ \hat{N}_S \mathcal{L}_{T, I} Q \hat{\rho}_I \} = \\ &\stackrel{(9)}{=} e \text{Tr} \{ \hat{\rho} \hat{N}_S \mathcal{L}_{T, I} Q \hat{\rho}_I \} \stackrel{(10)}{=} e \text{Tr} \{ \hat{N}_S Q \mathcal{L}_{T, I} Q \hat{\rho}_I \} \stackrel{(11)}{=} e \text{Tr} \{ \hat{N}_S Q \hat{\rho}_I \}. \end{aligned}$$

The chain of equalities are justified by:

- | | |
|---|--|
| (1) $[\hat{N}_{\alpha}, \hat{H}_S] = [\hat{N}_{\alpha}, \hat{H}_B] = 0$ | (6) $[A, BC] = B[A, C] + [A, B]C$ |
| (2) linearity of $\text{Tr} \{ \cdot \}$ and $[\cdot, \cdot]$ | (7) $\text{Tr} \{ [A, B] \} = 0$ |
| (3) $\hat{N} = \hat{N}_S + \sum_{\alpha} \hat{N}_{\alpha}$ | (8) $\mathcal{L}_{T, I} \hat{A} \equiv -\frac{i}{\hbar} [\hat{H}_{T, I}, \hat{A}]$ |
| (4) $[\hat{N}, \hat{H}] = 0$ | (9) $\text{Tr} \{ \hat{A} \} = \text{Tr} \{ Q \hat{A} \}$ |
| (5) $[\hat{N}_S, \hat{H}_S] = [\hat{N}_S, \hat{H}_B] = 0$ | (10) $\text{Tr}_B \{ \hat{O}_S \hat{O} \} = \hat{O}_S \text{Tr}_B \{ \hat{O} \}$ |
| | (11) Eq. (3.18) |

Eqs. (3.17), (3.18), (3.19) make the final link between the general theory of the reduced density matrix and the transport problem.

What still needs to be analyzed is now the structure of the many-body Hamiltonian.

3.4 The many-body approach to Q-transport

In systems with low conductance $G \ll G_0$ it is natural the separation between SYSTEM and BATH connected by weak tunnelling links. This leads to the total Hamiltonian

$$\hat{H}_{TOT} = \hat{H}_{res} + \hat{H}_S + \hat{H}_T + \hat{H}_{ext} \quad (3.20)$$

that we analyze here in greater detail. With respect of previous formulations in the course we added \hat{H}_{ext} in (3.20) to take into account the effects of external perturbations like for example an external gate voltage applied on the system or the electrostatic coupling to the metallic contacts.

In both cases \hat{H}_{ext} can be absorbed in \hat{H}_S and we will not give it any further importance. In second quantization, convenient to study many-body physics:

$$\hat{H}_{res} = \sum_{\alpha \vec{k} \sigma} \epsilon_{\alpha \vec{k}} c_{\alpha \vec{k} \sigma}^\dagger c_{\alpha \vec{k} \sigma} \quad (3.21)$$

where $\alpha = L, R$ and $c_{\alpha \vec{k} \sigma}^\dagger$ creates an electron with energy $\epsilon_{\alpha \vec{k}}$, \vec{k} is the quasi-momentum (Bloch states) and σ is the spin degree of freedom.

For simplicity we assume the leads (equiv contacts, equiv. reservoir) as reservoirs of non-interacting electrons.

For what concerns the system

$$\hat{H}_S = \sum_{i\sigma} \varepsilon_{i\sigma} d_{i\sigma}^\dagger d_{i\sigma} + \sum_{\substack{ijkl \\ \sigma\tau}} V_{ijkl} d_{i\sigma}^\dagger d_{j\tau}^\dagger d_{k\sigma} d_{l\tau} \quad (3.22)$$

which is the most generic interacting Hamiltonian for the system if $|i\sigma\rangle$ is a complete single particle basis. The fact that the sum over the spin components reduces to a $(\sigma, \text{and } \tau)$ depends on the nature of the Coulomb interaction that preserves spin. Other approximations can derive from the nature of the single particle orbitals. e.g. if they are extremely localized one obtains

$$\sum_{\substack{ijkl \\ \sigma\tau}} V_{ijkl} d_{i\sigma}^\dagger d_{j\tau}^\dagger d_{k\sigma} d_{l\tau} \approx \frac{1}{2} \sum_i V_{iiii} (d_{i\uparrow}^\dagger d_{i\uparrow} d_{i\downarrow} d_{i\downarrow}) \quad (3.23)$$

the so called Hubbard approximation. If the indices i, j, k, l refer instead to an cupular (or quasi-cupular) momentum

$$\sum_{\substack{ijkl \\ \sigma\tau}} V_{ijkl} d_{i\sigma}^\dagger d_{j\tau}^\dagger d_{k\sigma} d_{l\tau} \approx \sum_{ijk} V_{ik, j^* i^*} d_{i+k\sigma}^\dagger d_{j-k\tau}^\dagger d_{j\tau} d_{i\sigma}$$

and so forth. Finally

$$\hat{H}_T = \sum_{\alpha} \hat{H}_{T,\alpha} = \sum_{\alpha} \sum_{\vec{k}i\sigma} t_{\alpha\vec{k}i\sigma}^* c_{\alpha\vec{k}\sigma}^\dagger d_{i\sigma} + \text{h.c.} \quad (3.24)$$

where the crucial point is the determination of the tunnelling amplitudes $t_{\alpha\vec{k}i\sigma}^*$.

3.4.1 The tunnelling Hamiltonian

The idea of a second quantization description of tunnelling is due to Berdken [J. Berdken, Tunnelling from a many-body point of view, Phys. Rev. Lett., 6, 57 (1960)]. We will follow here the spirit of his observation, adapting it to a tunnelling nanostructure. In order to obtain the second quantization operator \hat{O} one starts from the first quantization one \hat{o} . In the case of tunnelling it is convenient to start from the single-electron Hamiltonian.

$$\hat{h} = \frac{\hat{p}^2}{2m} + \hat{V}(\hat{r}) \quad (3.25)$$

where $\hat{V}(\hat{r})$ is the electrostatic potential in the lead, tunnelling region and in the system. Because the Schrödinger equation related to this problem might be quite difficult to solve, it is more convenient to divide the potential in two components, the "extended contact" and the "extended system" components:

$$V(\vec{r}) = V_{res}(\vec{r}) + V_S(\vec{r}) \quad (3.26)$$

$$\text{where } V_{res}(\vec{r}) = \begin{cases} V(\vec{r}) & \vec{r} \in R_{res} \\ 0 & \text{otherwise} \end{cases}$$

$$V_S(\vec{r}) = \begin{cases} V(\vec{r}) & \vec{r} \in R_S \\ 0 & \text{otherwise} \end{cases}$$

where R_{res} and R_S are regions of space defining the reservoir and the relevant system.

$R_{res} + R_s$ gives back the entire space. Another way of stating the same concept is to identify $V_{res}(\vec{r})$ with the potential of the reservoir in absence of the system and $V_s(\vec{r})$ as the potential of the system in absence of the reservoir.

As a simple example consider the one for the spin on thin insulating film: $V(x_{hp}, y_{hp}, z)$

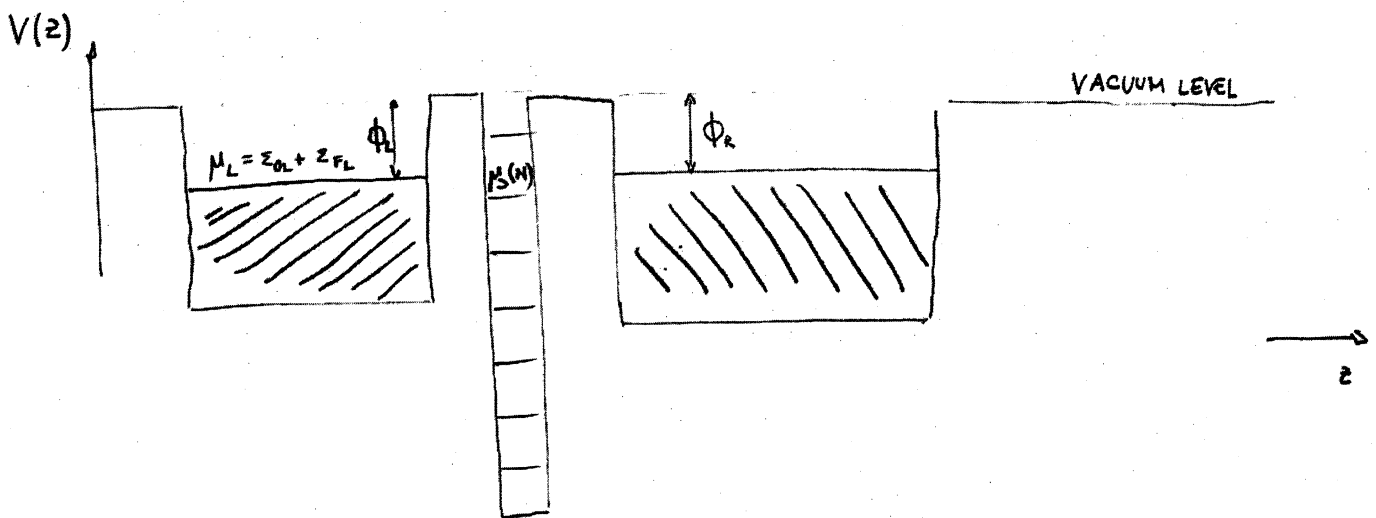

It holds then $V_{res} = V_{resL} + V_{resR}$, $V = V_s + V_{res}$

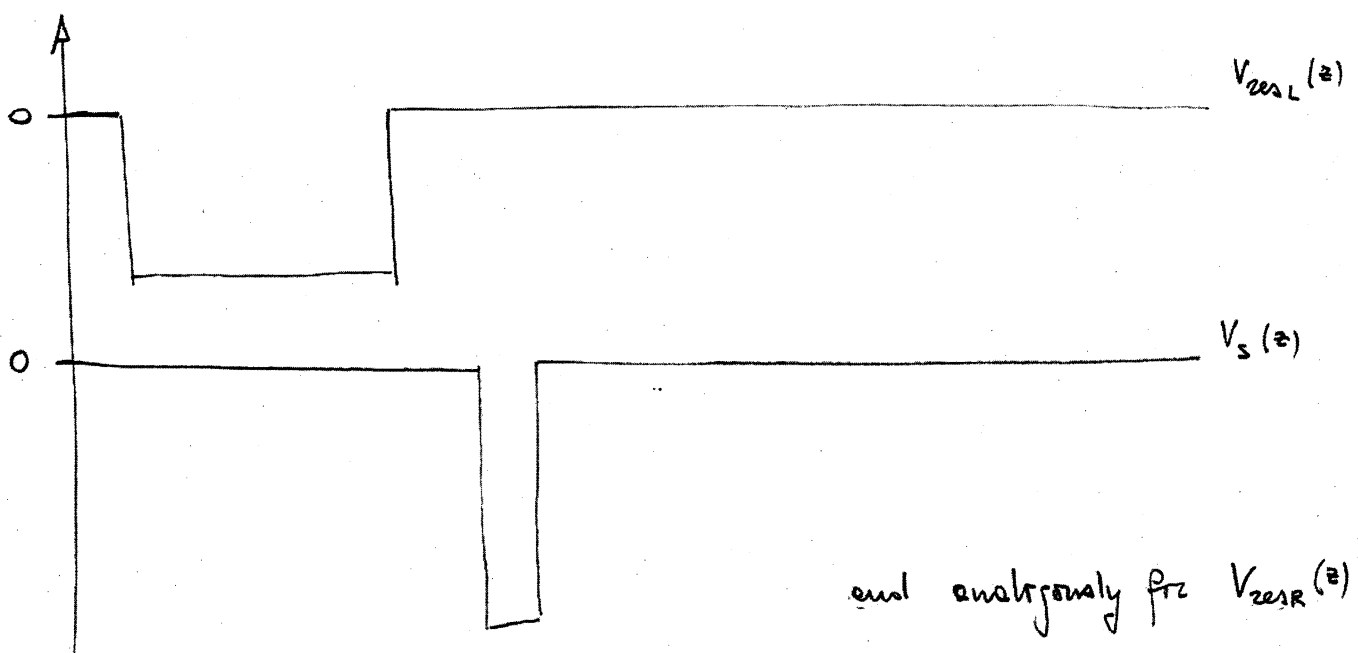

In the tunnelling structures that we are considering we are mainly interested in the tunnelling between bound states for the different structures \Rightarrow in negative energies (the vacuum level is conventionally set to 0.). The wave functions which solve the Schrödinger equation associated to

$$\hat{h}_S = \frac{\hat{p}^2}{2m} + \hat{V}_S \quad , \quad \hat{h}_{res,L} = \frac{\hat{p}^2}{2m} + \hat{V}_{res,L} \quad , \quad \hat{h}_{res,R} = \frac{\hat{p}^2}{2m} + \hat{V}_{res,R} \quad (3.27)$$

exhibit an exponential decay in the barrier regions, where the potentials $V_S, V_{res,L}, V_{res,R}$ are at the vacuum level. Let us introduce the eigenstates, eigenvalues

$$\hat{h}_S |i\sigma\rangle = \varepsilon_{i\sigma} |i\sigma\rangle \quad \hat{h}_{res,a} |\alpha\vec{k}\sigma\rangle = \varepsilon_{\alpha\vec{k}\sigma} |\alpha\vec{k}\sigma\rangle$$

$$t_{\alpha\vec{k}i\sigma} = \langle \alpha\vec{k}\sigma | \hat{h} | i\sigma \rangle = \langle \alpha\vec{k}\sigma | \frac{\hat{p}^2}{2m} + \hat{V}_S + \hat{V}_{res,L} + \hat{V}_{res,R} | i\sigma \rangle \quad (3.28)$$

$$= \int d\vec{r} \varphi_{\alpha\vec{k}\sigma}^*(\vec{r}) \hat{h}(\vec{r}) \psi_{i\sigma}(\vec{r})$$

Due to the localized nature of the wave function $\psi_{i\sigma}(\vec{r})$ the product of $\varphi_{\alpha\vec{k}\sigma}^*(\vec{r}) \psi_{i\sigma}(\vec{r})$ is moved towards the system and \hat{h} can be substituted by $\hat{h}_S \Rightarrow$ obtaining

$$t_{\alpha\vec{k}i\sigma} = \left[\int d\vec{r} \varphi_{\alpha\vec{k}\sigma}^*(\vec{r}) \psi_{i\sigma}(\vec{r}) \right] \varepsilon_{i\sigma} \quad (3.29)$$

i.e. one has to calculate overlap integrals.

Note: Very often the energy dependence of $t_{\alpha\vec{k}i\sigma}$ is neglected which brings to a very simple form for the tunnelling Hamiltonian

$$\hat{H}_{T,\alpha} = t \sum_{\vec{k}i\sigma} e^{i\vec{k}\vec{r}_i} d_{i\sigma} + \text{h.c.} \quad (3.30)$$

3.4.2 The field operator description

Especially when dealing with complex interacting systems, whose Hamiltonian can be diagonalized in the quasi-continuum description of their degrees of freedom (i.e. interacting sites as lattice liquids), a field operator description of the tunnelling Hamiltonian and of the associated current operator can be useful. We introduce the field operators

$$\begin{aligned} \hat{\Phi}_{\alpha\sigma}^{\dagger}(\vec{r}) &= \sum_{\vec{k}\tau} \langle \alpha\vec{k}\tau | \vec{r}\sigma \rangle c_{\alpha\vec{k}\tau}^{\dagger} \\ \hat{\Psi}_{\sigma}^{\dagger}(\vec{r}) &= \sum_{i\tau} \langle i\tau | \vec{r}\sigma \rangle d_{i\tau}^{\dagger} \end{aligned} \quad (3.31)$$

and, correspondingly

$$\begin{aligned} c_{\alpha\vec{k}\sigma}^{\dagger} &= \sum_{\tau} \int \frac{d\vec{r}}{V} \langle \vec{r}\tau | \alpha\vec{k}\sigma \rangle \hat{\Phi}_{\alpha\tau}^{\dagger}(\vec{r}) \\ d_{i\sigma}^{\dagger} &= \sum_{\tau} \int \frac{d\vec{r}}{V} \langle \vec{r}\tau | i\sigma \rangle \hat{\Psi}_{\tau}^{\dagger}(\vec{r}) \end{aligned} \quad (3.31b)$$

It follows

$$\begin{aligned} \hat{H}_{T,\alpha} &= \sum_{i\vec{k}\sigma} t_{\alpha\vec{k}i\sigma}^* \int \frac{d\vec{r}}{V} \int \frac{d\vec{r}'}{V} \langle \vec{r}\sigma | \alpha\vec{k}\sigma \rangle \langle i\sigma | \vec{r}'\sigma \rangle \hat{\Phi}_{\alpha\sigma}^{\dagger}(\vec{r}) \hat{\Psi}_{\sigma}(\vec{r}') \\ &\quad + \text{h.c.} \end{aligned}$$

It is convenient to introduce the tunnelling function

$$T_{\alpha\beta}^{(0)*}(\vec{r}, \vec{r}') = \frac{1}{V^2} \sum_{\vec{k}} t_{\alpha\vec{k}\beta}^* \langle \vec{r}' | \alpha \vec{k} \rangle \langle \beta | \vec{r} \rangle \quad (3.32)$$

In view of what discussed in the subsection 3.4.1 it is easy to demonstrate that $T_{\alpha\beta}^{(0)*}(\vec{r}, \vec{r}') = \delta(\vec{r} - \vec{r}') T_{\alpha\beta}(\vec{r})$ thus obtaining

$$\hat{H}_{T,\alpha} = \sum_{\beta} \int d\vec{r} T_{\alpha\beta}^*(\vec{r}) \phi_{\alpha\beta}^+(\vec{r}) \psi_{\beta}(\vec{r}) + \text{h.c.} \quad (3.33)$$

The tunnelling function describes in which region of space the tunnelling takes place. Also the tunnelling current can be expressed in terms of field operators and tunnelling function.

$$\hat{N}_{\alpha} = \sum_{\vec{k}\beta} c_{\alpha\vec{k}\beta}^{\dagger} c_{\alpha\vec{k}\beta} = \sum_{\beta} \int d\vec{r} \phi_{\alpha\beta}^+(\vec{r}) \phi_{\alpha\beta}(\vec{r}) \quad (3.34)$$

It follows from (3.9)

$$\begin{aligned} \hat{I}_{\alpha} &= -\frac{ie}{\hbar} [\hat{H}_{T,\alpha}, \hat{N}_{\alpha}] = \\ &= -\frac{ie}{\hbar} \sum_{\beta\beta'} \int d\vec{r} \int d\vec{r}' T_{\alpha\beta}^*(\vec{r}) [\hat{\phi}_{\alpha\beta}^+(\vec{r}) \hat{\psi}_{\beta}(\vec{r}), \hat{\phi}_{\alpha\beta'}^+(\vec{r}') \hat{\phi}_{\alpha\beta'}(\vec{r}')] + \text{h.c.} \\ &= -\frac{ie}{\hbar} \sum_{\beta} \int d\vec{r} [-T_{\alpha\beta}^*(\vec{r}) \hat{\phi}_{\alpha\beta}^+(\vec{r}) \hat{\psi}_{\beta}(\vec{r}) + T_{\alpha\beta}(\vec{r}) \psi_{\beta}^{\dagger}(\vec{r}) \phi_{\alpha\beta}(\vec{r})] \end{aligned}$$

where we have used the canonical anticommutation rules

$$\{\phi_{\alpha\beta}(\vec{r}), \phi_{\alpha\beta'}^{\dagger}(\vec{r}')\} = \delta_{\beta\beta'} \delta(\vec{r} - \vec{r}')$$